



H3™

Running Man Exit Sign



Product Features

- SKU # 155392
- Output power: 3.5W
- CCT: 6000K-7000K
- Injection-molded thermoplastic ABS housing
- Charging Time: 24H
- Discharging Time: 90 MIN
- Input Volt: 120/347V/60Hz
- Battery: 3.6V 2000mAh Ni-Cd Battery
- IP Rating: IP20
- LED: 14 LEDS
- Certifications: UL Listed
- Warranty: (5 years warranty for the electrical parts and housing; 3 years warranty for battery)"



SKU Number 155392

Specifications

Parameter	Description	Value
General Performance	Model	JRMEEW
	Mode of operation	Maintained
	Supply Voltage	120/347V/60Hz
	Power Consumption	4.5W
	Output Voltage	4.5VDC
	Output Power	3.5W
	Colour Temperature	6000K -7000K
	Battery	3.6V 200mAh Ni-Cd Battery
	Max Charge Current (mA)	AC:85mA/DC:95mA
	Max Discharge Current (mA)	185mA
	Charging Time	24H
	Discharge Time	90Min
	LED	14 LEDS
	Net Weight	2.58LBS
	Gross Weight	2.64LBS
	IP Rating	IP20
	Safety Classification	
	Certification	UL Listed
	Picture	
Warranty	Five years warranty for the electrical parts and housing; Three years warranty for battery.	





H3™

Running Man Exit Sign

Dimensions

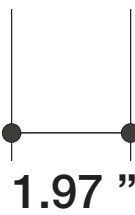
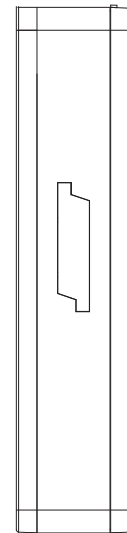
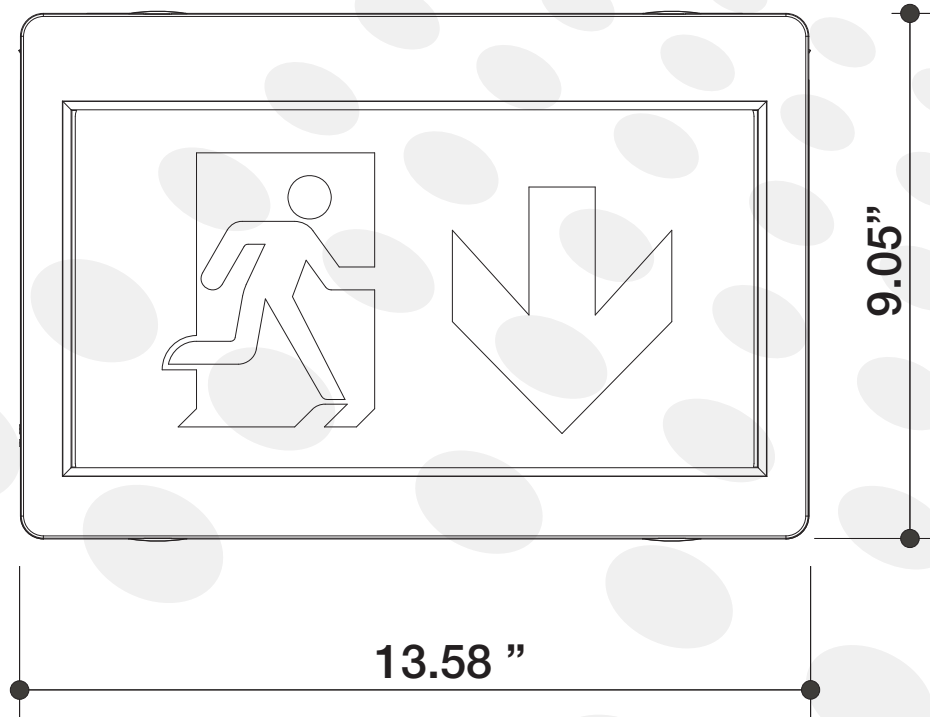



Installation

LED Pictogram Sign

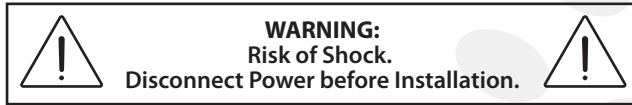

IMPORTANT SAFEGUARDS

When using electrical equipment, basic safety precautions should always be followed including the following:

READ AND FOLLOW ALL SAFETY INSTRUCTIONS

1. All servicing should be performed by qualified service personnel.
2. Disconnect power at fuse or circuit breaker before installing or servicing.
3. All electrical connections must be in accordance with local codes, ordinances and the National Electric code.
4. Do not use outdoors.
5. Do not let power supply cords touch hot surfaces.
6. Do not mount near gas or electric heaters.
7. Equipment should be mounted in locations and at heights where it will not readily be subjected to tampering by unauthorized personnel.
8. The use of accessory equipment not recommended by the manufacturer may cause an unsafe condition.
9. Do not use this equipment for other than intended use.
10. Use caution when handling batteries. Battery acid can cause burns to the skin and eyes. If acid is spilled on the skin or eyes, flush acid with fresh water and contact a physician immediately. Avoid possible shorting.
11. Allow battery to charge for 24 hours before first use.

SAVE THESE INSTRUCTIONS

Installation Instructions

1. Turn off AC power.
2. Using a flat head screwdriver, insert the blade into the two slots and pry off the front cover (see figure 4).
3. Follow the proper mounting procedure below.

Wall mount

- a. Remove the back plate from the packaging.
- b. Knock out the proper hole pattern on the back plate, including the center hole, to mount to a standard junction box by supporting the area around the knock outs with two blocks of wood.
- c. Remove the rear cover and diffuser.
- d. Install the back plate on to the unit.
- e. Feed the AC supply leads out through the center hole and make the proper connections (See step 4 and Fig.6).

Ceiling or End Mount

- a. Attach crossbar to junction box, set the longer blade of the crossbar to touch the junction box.

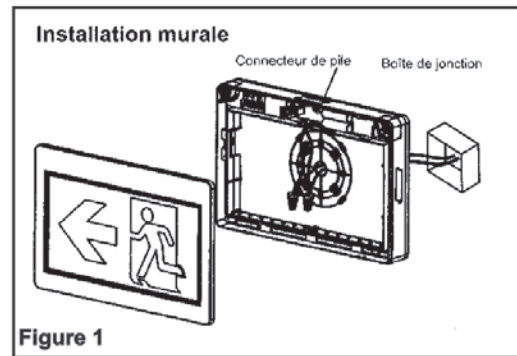
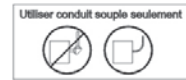

Figure 1

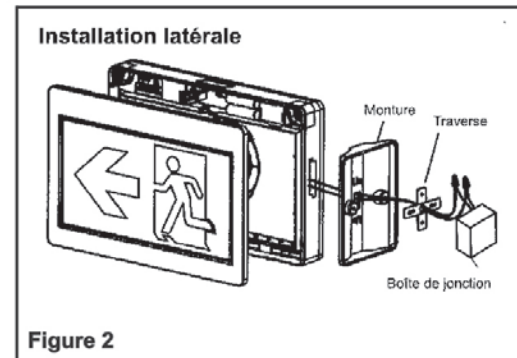

Figure 2

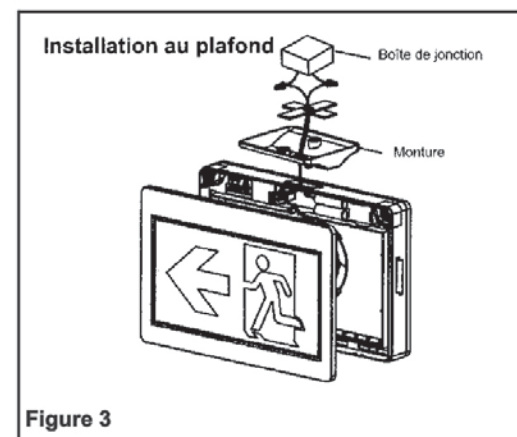

Figure 3

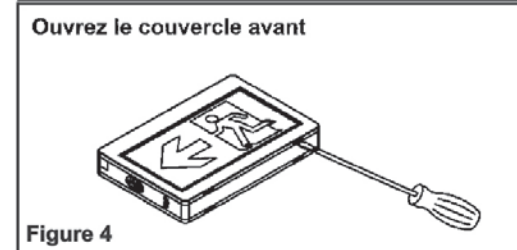

Figure 4



H3™

Running Man Exit Sign

Installation

- b. Remove the mounting hole cover from the top or side of the unit depending on your mounting configuration (see figures 2 or 3).
 - c. Install canopy according to mounting configuration (see figure 6).
 - d. Feed the unit wires through canopy hole and make the proper connections (See step 4 and Fig.6).
4. Make the proper connections (see figure 6):
 - a. For 120VAC, connect the black wire (120VAC) and white wire (neutral) to the building utility.
 - b. For 347VAC, connect the red wire (347VAC) and white wire (neutral) to the building utility.
 - c. Feed wires back into the junction box.

 **CAUTION!** Risk of electrical shock. Cap unused wires. In all cases, use suitable wire nuts rated for the applicable voltage to connect to wires.

5. For universal AC/DC models: connect wires for external DC supply (see figure 6)
 - a. Wire the Yellow lead to the positive(+)
 - b. Wire the Purple to the Negative(-)

 **IMPORTANT!** Electrical connections for AC and DC wires must be isolated from each other.

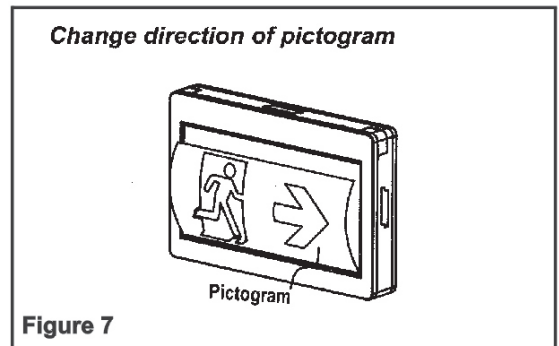
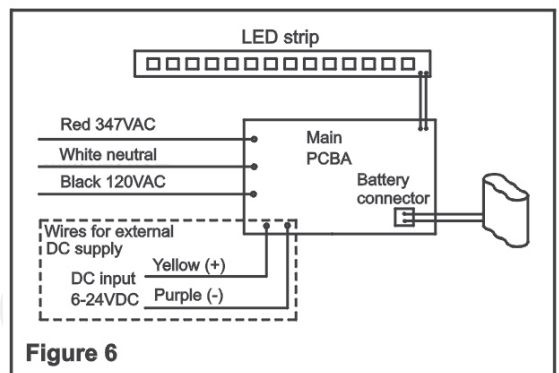
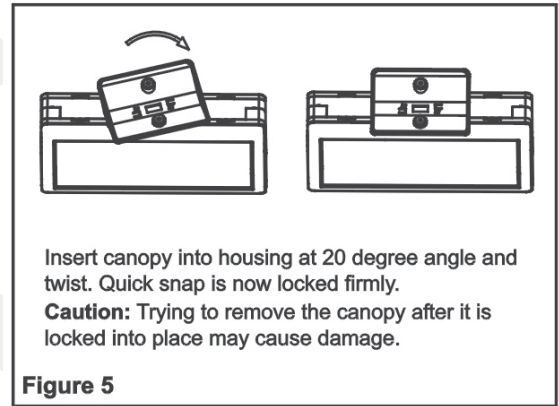

PACKAGE

Carton (Inch)	Qty / Carton	Net Weight / Carton	Gross Weight / Carton
14.37x9.76x6.14	2PC	5.07LBS	6.17LBS

H3™

Running Man Combo Exit Sign



Application Picture



LED EMERGENCY LIGHTS

Warranty

Five years warranty for the electrical parts and housing;
Three years warranty for battery